

# UNIVERSELLE GRIFFBÜGEL

- Schwenkbarer Tragegriff/Aufstellbügel aus Zink-Druckguss
- Dazu passendes Al-Profil in der passenden Breite Ihres Gehäuses als separates Verkaufsteil.

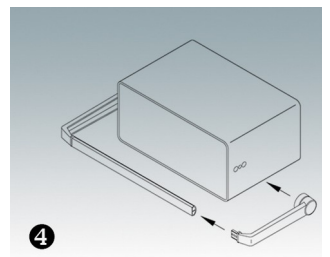

## Versionen

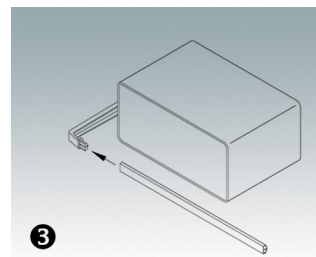
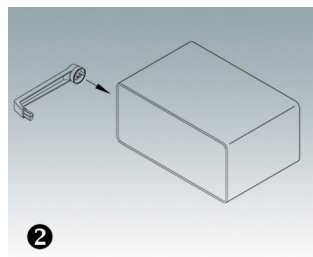
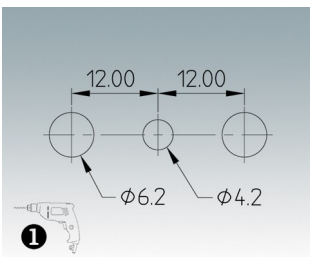
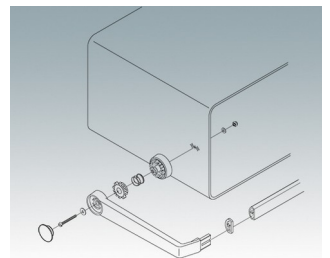
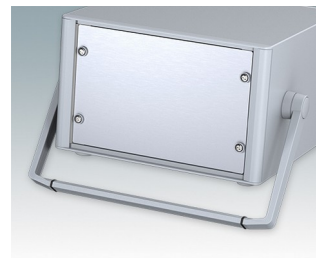
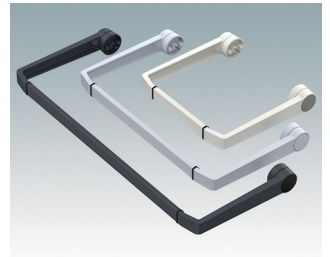
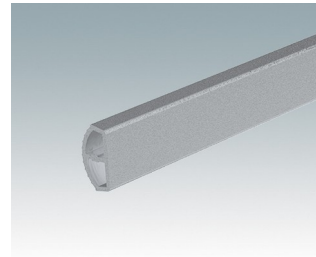
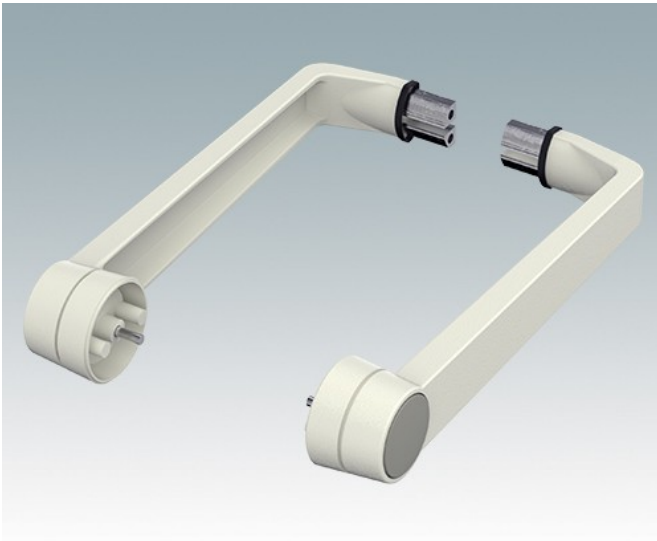
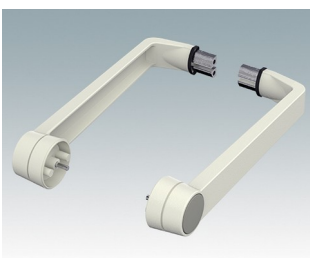

**A9300014**  
Griffbügel Seitenteile  
Zink  
Grauweiß RAL 9002

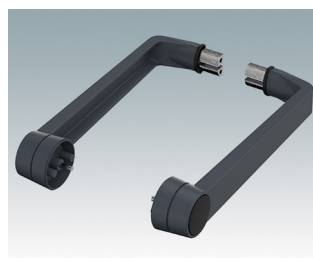

**M5093004**  
Griffbügel Seitenteile  
Zink  
Anthrazit RAL 7016

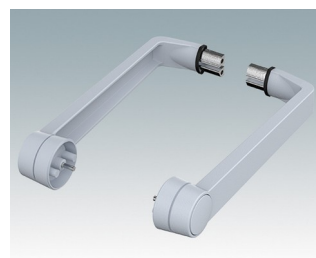

**M5093005**  
Griffbügel Seitenteile  
Zink  
Lichtgrau RAL 7035

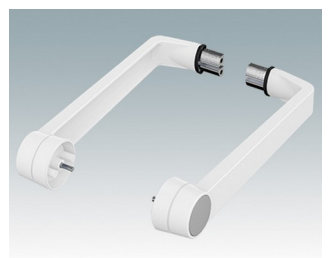

**M5093006**  
Griffbügel Seitenteile  
Zink  
Verkehrsweiß RAL 9016



M5093009  
Griffbügel Seitenteile  
Zink  
Schwarz RAL 9005

## Systemkomponenten zum Komplettieren

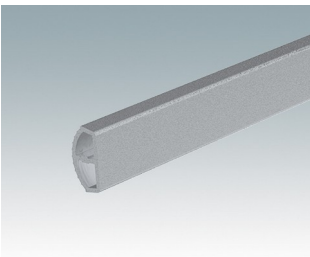

M50930-xxx  
Griffprofil, RAL 9006  
Aluminium  
Weißaluminium RAL 9006

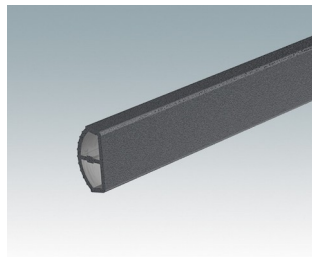

M50934-xxx  
Griffprofil, RAL 7016  
Aluminium  
Anthrazit RAL 7016

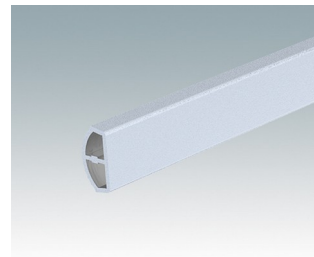

M50935-xxx  
Griffprofil, RAL 7035  
Aluminium  
Lichtgrau RAL 7035

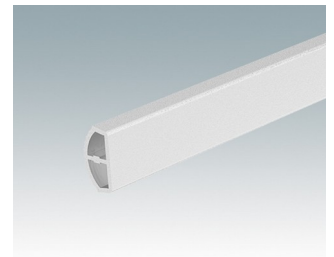

M50936-xxx  
Griffprofil, RAL 9016  
Aluminium  
Verkehrsweiß RAL 9016

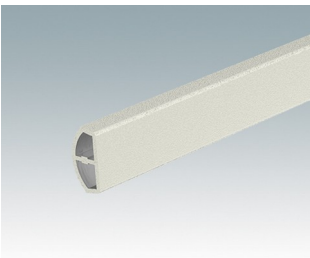

M50937-xxx  
Griffprofil, RAL 9002  
Aluminium  
Grauweiß RAL 9002

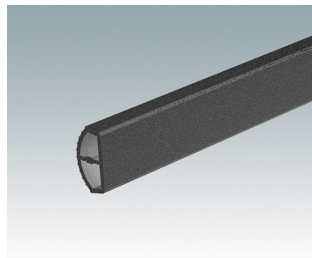

M50939-xxx  
Griffprofil, RAL 9005  
Aluminium  
Schwarz RAL 9005

Technische Änderungen vorbehalten. © OKW Enclosures Ltd